

Table of Contents

Introduction	vii
KEYPAD INFORMATION	1
General	1
Number Keys (0 – 9)	1
View Keys (A and B)	1
Enter Key (ent)	2
Escape Key (esc)	2
Hash Key (#)	2
Star Key (*)	2
Power LED	2
Banner	2
User Codes	2
SETTING THE SYSTEM	3
Before Setting	3
Entering A Pin - User Level 1-2	3
Entering A Pin - User Level 3 - 6	3
Setting groups	3
Exit time	3
Sounder	4
Zones Open	4
Final Door/Terminator	4
System Set	4
Part Setting	4
Cancelling The Setting	4
Group Name	4
MICROMAX SETTING OPTIONS	5
Setting with the MicroMAX Cards	5
Dual Focus	5
Proximity Keypads	5
UNSETTING THE SYSTEM	6
Normal Entry	6
Straying From the Entry Route	6
Slow Entry	6
Cancelling Alarms	6
Manager Reset	6
Engineer Reset	6
Unsetting with the MicroMAX Cards	6
MENU OPTIONS	7
Full Menu	7

Quick Menu ----- 7

Accessing The Menu ----- 8

Full Menu ----- 8

Quick Menu ----- 8

Omit Zones (User Level 3 And Above) ----- 9

Purpose ----- 9

Selecting Omit Zones ----- 9

Viewing Eligible Zones ----- 9

Omitting Zones ----- 9

Setting With Omitted Zones ----- 9

Vibration Zones (504 & 512 Only) ----- 9

Atm 1/2/3/4 Zones (512 Only) ----- 10

Forced Set (User Level 3 and Above) ----- 10

Purpose ----- 10

Selecting Forced Set ----- 10

Non-omittable Zones ----- 10

Chime (User Level 3 and Above) ----- 11

Purpose ----- 11

Selecting Chime ----- 11

Chime In Operation ----- 11

Display Zones (User Level 4 and Above) ----- 11

Purpose ----- 11

Selecting Display Zones ----- 11

Address ----- 11

Function ----- 11

Status ----- 12

Description ----- 12

Selecting And Viewing ----- 12

Escape ----- 12

Display Log (User Level 4 and Above) ----- 12

Purpose ----- 12

Selecting Display Log ----- 12

Events ----- 12

Selecting a Date ----- 12

Viewing Each Event ----- 12

Additional Information ----- 13

Printing ----- 13

Print (User Level 4 and Above) ----- 13

Purpose ----- 13

Selecting Print ----- 13

Codes ----- 13

Zones ----- 13

Log ----- 13

All -----	13
Help Message -----	13
Walk Test (User Level 5 and Above) -----	14
Purpose -----	14
Selecting Walk Test -----	14
All Zones -----	14
Selected Zones -----	14
Ending Walk Test -----	14
Time/Date (User Level 6) -----	15
Purpose -----	15
Selecting Time/Date -----	15
Changing Time -----	15
Changing Date -----	15
Advance and Retard -----	15
Codes (User Level 6) -----	16
Purpose -----	16
Manager Code -----	16
Selecting Codes -----	17
User Codes -----	17
Modify Pin -----	17
Modify Level -----	18
Duress Code -----	18
Quick Menu -----	19
Modify Name -----	19
Time Zone (Galaxy 60, 128, 500, 504 and 512) -----	19
Temporary Codes (Galaxy 128, 500, 504 and 512) -----	20
Pin Change (Galaxy 128, 500, 504 and 512) -----	20
Modify Groups (Galaxy 18, 60, 128, 500, 504 and 512) -----	21
Single Groups -----	21
Multiple Groups -----	21
Group Choice -----	22
Max Number -----	22
Max Function -----	23
Max Keypad -----	23
“Card- Held” Max Operation -----	23
Forgive Antipassback -----	23
Pin Warning -----	24
Max Users (Pre V4 Only) -----	24
Groups (Pre V4 Only) -----	25
Summer (User Level 6) -----	25

AVOIDING FALSE ALARMS	26
ZONE REFERENCE TABLES	27
ALARM AND HELP MESSAGES	28
Other Keypad In Use (Galaxy 8 And 18 Only)	28
Alarm In Progress	28
PA Reset Required	28
Manager Reset Required	28
Engineer Reset Required	28
No Entries	28
Invalid Selection	28
Invalid Code	28
Technistore Reset	28
No Modules Added	28
INSTALLER DETAILS	29

INTRODUCTION

The Galaxy alarm system is, in fact, a computer which has been designed using the latest software and hardware technology.

First and foremost, the Galaxy meets all your security needs. The engineer will program and commission the system to your own exacting requirements.

Warning:

There are no user serviceable parts inside. Please refer all servicing to a qualified installer.

KEYPAD INFORMATION

General

The Galaxy Alarm system is controlled by Galaxy Mk7 Full Alpha Liquid Crystal Display (LCD) keypads. A maximum of 16 keypads may be connected to the Galaxy 8, 18 and 60 and 128 control panels. A maximum of 32 keypads may be attached to the Galaxy 500, 504 and 512 control panels.

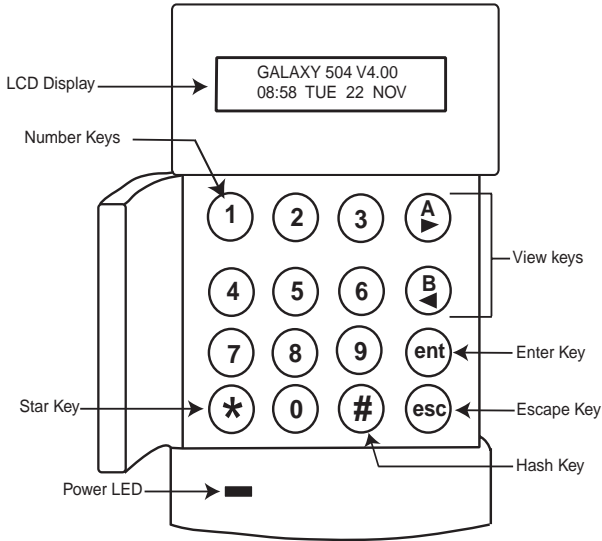

Number Keys (0 – 9)

These keys are used to enter the code and to select and modify options.

Before carrying out operations on the system, users must identify themselves with a Personal Identification Number (PIN). This number is a 4, 5 or 6 digit number selected from keys 0 - 9.

The number keys are also used where groups are programmed on the system permitting groups (areas) to be set or unset.

View Keys (A and B)

These keys have been programmed to activate one of the system options. Pressing the **A** > key after a valid code has been entered starts the full set routine. Pressing the < **B** key after a valid code has been entered starts the part set routine.

Once a system option has been selected, the **A** > or < **B** keys can be used to operate as view keys, stepping forwards (**A** >) or backwards (< **B**) through lists of information. Holding down a view key while viewing an option list, rapidly displays each item in the list, permitting quick access to the information.

Enter Key (ent)

The **ent** key accepts and processes entered data. Valid actions are performed and the next option is accessed.

Escape Key (esc)

The **esc** key aborts the current option to return to the previous option level. Any option modification made prior to the option being aborted is erased. Successive pressing of the **esc** key returns the user to the start display (known as the BANNER).

The **esc** key also aborts the setting routine if pressed during the exit time.

Hash Key (#)

The **#** key is used to display additional choices for certain options, e.g. ADVANCE/RETARD the time in the **Time/Date** option.

This key is also used as the user duress key (**by pressing twice following a valid code entry**).

Star Key (*)

The ***** key is used to provide additional features for certain options, e.g. printing the event log or deleting entries.

Power LED

The green power LED remains lit whenever the keypad is connected to a mains power supply. A mains power failure is indicated by the LED flashing slowly. The LED flashes rapidly if the battery voltage falls below the minimum threshold or if one of the fuses on the control panel PCB blows.

Banner

The banner is the display shown on the keypad, e.g. **Galaxy 504 V4.00** (with the time and date on the bottom line). This is shown at all times when the system is unset, unless the menu is being accessed or an alarm or help message is on the display. The banner can be changed by the engineer. In the set condition the banner is normally blank.

User Codes

The user code is a unique four, five or six digit PIN (Personal Identification Number). The PIN identifies the user to the Galaxy Alarm panel and allows operation of the system.

SETTING THE SYSTEM

Before Setting

Before setting the system ensure all doors and windows are secured and areas protected by movement detectors are free from obstruction.

Code + ent or A >



Entering A Pin - User Level 1-2

As each digit is entered the keypad responds with a bleep and displays a *. When all the digits are entered, press the **ent** or **A >** key to start the setting routine.

Entering A Pin - User Level 3 - 6

As each digit is entered the keypad responds with a bleep and displays a *. When all the digits are entered press the **A >** key to start the setting routine.

Code + A



1



ent



Code + A



A Key



ent



Setting groups

Where group choice has been assigned to the PIN, select which groups have to set as part of the setting routine. The set status of each group is displayed on the keypad screen. Possible status options are :-

R = Ready (Groups is unset, and all zones are closed)

F = Faulted (Group is unset, and at least one zone is open)

S = Set (Group is set)

L = Lockout (Group is locked out, and cannot be unset)

Select which groups have to be set by entering the number of the group. For example, to set groups 2 and 3 press keys **2** and **3**. The display changes to indicate the groups selected for setting. Pressing the **ent** key starts the setting routine for the specified groups.

The Galaxy 500, 504 and 512 have more than 8 groups. If the user has group choice, the available groups will be displayed at the keypad following a valid code + **A >**. The groups will be displayed showing A1 to A8. Use both **A >** and **< B** keys to scroll to the various sets of groups. If the user does not have group choice, entering the PIN and **A >** will cause all groups assigned to the user to set.

Exit time

If all the system zones are closed when the setting routine is started, the display indicates the remaining time, in seconds, to vacate the premises. Exit the building using the agreed route.

MICROMAX SETTING OPTIONS

Setting with the MicroMAX Cards

The MicroMAX user cards can be used to set the system. This is done by assigning a MAX user card (or fob) with one of the setting options. When the MAX card is held against a MAX module for three seconds, the MAX function is activated. For example, if the MAX function assigned is **13 = Part Set**, then activating the card held function results in the system being part set.

If a user is assigned group choice, then a keypad will have to be accessed to select the group for setting after swiping the card.

Dual Focus

If a # is assigned to a particular users pin and their max card number, then the user will have dual focus operation. This means that they will have to enter their pin first, before setting with the max card and vice versa.

Proximity Keypads

A proximity keypad is a keypad that has a card reader built in. They are normally installed on systems where dual focus setting and unsetting are used. Proximity keypads are used as a keypad and microMAX as detailed above, but the card is held against the lower right corner of the keypad as shown in the following diagram:



UNSETTING THE SYSTEM

Normal Entry

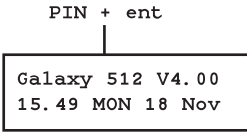

Unsetting starts immediately when the **FINAL** door is opened or an **ENTRY** zone is activated. The sounder pulses slowly and the user must go directly to the keypad and enter a valid PIN, followed by **A>**, **<B** or **ent**. Users with group choice, will access the UNSET screen following PIN entry. This permits the user to unset specific groups. To return to the SET screen press **ent**.

Straying From the Entry Route

Go directly to the keypad when entering the building. If the user strays into a protected area and activates a zone, a full alarm will occur. The police may be called out and the system will have to be reset.

Slow Entry

Enter a valid PIN before the entry time expires. If the entry time expires before a valid PIN is entered, then a full alarm will occur. The sounder begins to pulse quickly when 75% of the entry time has elapsed indicating time is running short.

Cancelling Alarms

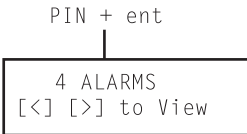

To cancel an alarm, enter a valid PIN followed by **ent** at the keypad. The keypad displays details of the zone activated. When more than one zone is activated, details can be viewed using **A >** or **< B**. Press **ent** to return to the banner. Certain types of alarms, once cancelled, require a code with the appropriate reset authorisation to be entered. The system prompts for a valid reset code by displaying **Manager Reset Required** or **Engineer Reset Required** on the keypad.

Manager Reset

Entering a manager level PIN followed by **ent**, resets the system following an alarm activation.



Engineer Reset

Certain types of alarm require an engineer to visit the site and, after investigation, reset the system. In such cases, the system cannot be reset until the engineer reset has been carried out.



Unsetting with the MicroMAX Cards

If any of the groups assigned to the MicroMAX are set, then swiping the MicroMAX module with a card unsets the groups. Group choice and dual focus operation, where implemented will apply as per setting instructions.

MENU OPTIONS

There are two menu structures on the Galaxy control panels:

Full Menu

Only accessed by default by the Manager code on the Galaxy 60, 128, 500, 504 and 512 control panels.

Quick Menu

A selection of options from the full menu. The quick menu is the default menu access for all user codes (level three and above) as well as the Manager code on the Galaxy 8 and 18 control panels.

User Level	Quick Menu	Full Menu			
		Level 3	Level 4	Level 5	Level 6
3	0 = Omit Zones	10 = Setting	20 = Display	30 = Test	40 = Modify
3	1 = Forced Set	11 = Omit Zones	21 = Display Zones	31 = Walk Test	41 = Time/Date
3	2 = Chime	12 = Timed Set	22 = Display Log	32 = Outputs	42 = Codes
4	3 = Display Zones	13 = Part Set	23 = System		43 = Summer
4	4 = Display Log	14 = Forced Set	24 = Print		44 = Trace
4	5 = Print	15 = Chime	25 = Access Doors		45 = Timer Control
5	6 = Walk Test	16 = Instant Set			46 = Group Omit
6	7 = Time/Date	17 = Instant Part			47 = Remote Access
6	8 = Codes	18 = Home Set			48 = Eng. Access
6	9 = Summer	19 = All set			49 = Timelock

Table 1. Menu Options

Accessing The Menu

To access the menu enter a valid code and press the **ent** key. The Full Menu or Quick Menu is accessed, depending on the user level.

- Note:**
1. If the user does not have group choice, all groups assigned to the user code must be unset.
 2. If the user has group choice, at least one group on the system must be unset.
 3. If there are no groups, then the system must be unset.

Full Menu

The Full Menu has a hierarchy of four structures contained within it. Each structure is accessible by an increased user code level.

Quick Menu

The Quick Menu offers users level three and above a selection of up to 10 options, numbered 0 – 9. The required option is selected by entering the option number (0 – 9) or by using the **A** > or < **B** keys to display each option.

The menu options (as with all Galaxy lists) are circular, therefore menu option 9 is followed by menu option 0.

The following Quick Menu options are the factory default settings. Each option is described in the following pages.

Chime (User Level 3 and Above)

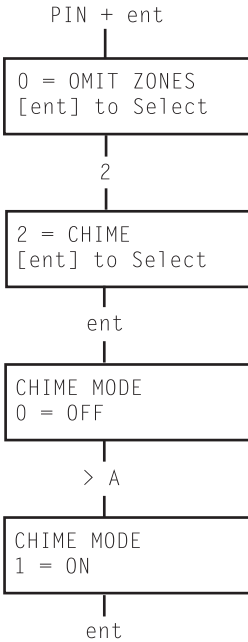

Purpose

The **Chime** mode is switched on and off by this option. When the **Chime** mode is on, any zones that have been programmed by the engineer for chime will activate momentarily when opened.

Note: Your system may not require any zones of this type.

Selecting Chime

Enter the QUICK MENU. Press key **2** followed by the **ent** key. The display shows the ON/OFF status of the **Chime** mode. Press the **>A** key to toggle between the states and press the **ent** key to accept the selection.

Note: Keys **1** AND **0** can also be used to select ON and OFF respectively.

Chime In Operation

When switched ON, the **Chime** mode remains active until switched OFF again. Zones that have been programmed with the chime attribute by the engineer continue to chime when they are activated.

Note: The **Chime** mode is suspended while the system is set or during an alarm.

Display Zones (User Level 4 and Above)

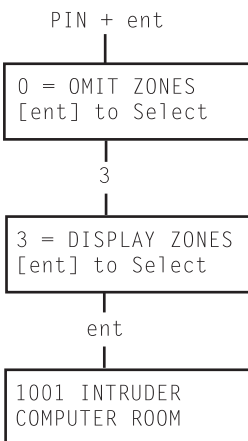

Purpose

This menu option provides the user with a method of accessing the **Display Zones** mode and checking each zone for its description and current status.

Selecting Display Zones

Enter the QUICK MENU. Press key **3** followed by the **ent** key. Details of the first zone (1001) are displayed.

Address

The zone address provides a unique four digit address number used for identification and selection, e.g. 1026 - line 1, RIO 02, zone 6 (Galaxy 500).

Function

The zone function is displayed and identifies the operation of the zone, e.g. INTRUDER, FIRE.

Status

The current status of the zone is displayed as circuit information, e.g. Open or Closed. This information alternates with function information.

Description

The zone description, if programmed, is displayed on the bottom line of the display. The descriptor is assembled from alpha-numeric text and describes the zone in detail, e.g. West Office Door.

```
1001 INTRUDER
COMPUTER ROOM
```

2+1

```
1021 SECURITY
CASHIER DOOR
```

esc

Selecting And Viewing

Selecting the **Display Zones** option displays the first zone address available on the system. Other zones can be viewed sequentially by using the >A or <B keys. Zones can also be displayed by entering the address of the zone: Galaxy 8 enter the zone number (1 digit); Galaxy 18 and 60 enter the RIO and zone number (2 digits); Galaxy 128, 500 504 and 512 enter the line, RIO and zone number (4 digits). Press the # key to display the zone resistance and RIO voltage.

Escape

The esc key aborts the option and returns to the option menu.

Display Log (User Level 4 and Above)

PIN + ent

```
0 = OMIT ZONES
[ent] to Select
```

4

```
4 = DISPLAY LOG
[ent] to Select
```

ent

```
* LOG      A12345678
Groups    NN-----
```

1 + 2

```
LOG      A12345678
Groups    YY-----
```

ent

```
08:53 TUE 22 NOV
AC FAIL-RIO108
```

<B (hold)

```
MON 21 NOV 1999
```

```
MON 20 NOV 1999
```

Purpose

The **Display Log** option provides the user with a means of viewing the system history. Events are recorded in detail and stored in the non-volatile memory.

Selecting Display Log

Enter the QUICK MENU. Press key 4 followed by the ent key. Details of the most recent event to be logged are displayed.

Events

The events available for display include details of setting, unsetting and alarms. Each event is timed and date stamped.

Selecting a Date

Hold down one of the view keys, the dates held in the log are rapidly stepped through. The >A key moves forward through the dates and the <B moves backwards. Stopping at the required date reveals the first event for that date.

Viewing Each Event

The entire events of any one date can be viewed by progressively stepping through the events using the >A and <B view keys. * If the user has group choice enabled, the groups will display. Events for each group can be displayed by entering the group number.

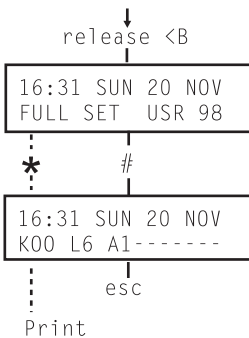

Additional Information

The # key can be used to reveal additional information on some types of events. This information is displayed on the bottom line. The information includes details such as zone descriptors, user levels and which keypad was used.

Printing

If a serial printer is connected to the system, a system history can be printed by pressing the * key. The system will print from the event on display until the most recent event.

Print (User Level 4 and Above)

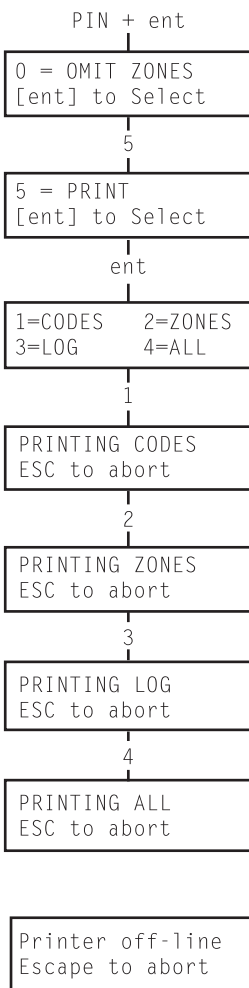

Purpose

The **Print** option gives the user the opportunity to get a hard copy print-out of the system details. This option requires a serial printer to be connected to the system.

Selecting Print

Enter the QUICK MENU. Press key **5** followed by the **ent** key. The system print options are displayed. Pressing the **esc** key aborts the PRINT option.

Codes

Press key **1** to start the print-out of all the codes, giving the user number, name, level and length of code.

Zones

Select the **Zones** option to print-out the details of each zone in the system. The zone address, function, and descriptor is printed. Press key **2** to select this option.

Log

The entire LOG can be printed out by selecting key **3**. The print-out consists of up to 1000 events depending on panel type, and details the time and date of setting, unsetting and alarms.

All

All the options (CODES, ZONES, and LOG) can be printed out by selecting the **ALL** option. Pressing key **4** delivers a print-out starting with user codes.

Help Message

If a print-out is started without a printer being connected and on-line, the display indicates that the printer is off-line.

Walk Test (User Level 5 and Above)

Purpose

The **Walk Test** option provides a method of testing the zones to ensure that they are operating correctly. There are two options available:

1. All zones can be tested
2. Selected zones can be tested

In both cases the sounder indicates an open zone. The test is recorded in the log. Wire-free zones also show the received signal strength as a percentage

Selecting Walk Test

Enter the QUICK MENU. Press the key **6** followed by the **ent** key. When **Walk Test** is selected, **Test All Zones** or **Selected Zones** displays.

All Zones

Choosing **All Zones** (press key **1**) starts the test immediately. No selection is necessary as all valid zones are included in the test. The sounder operates whenever a zone is opened and stops when all zones are closed.

Note: The **Test All Zones** option only tests zones which can be omitted from the system.

Selected Zones

Choosing the **Selected Zones** option by pressing key **2** displays the first zone on the system. Each zone is displayed in turn by using the **>A** or **<B** keys. When the zone to be included in the test is displayed, press the **#** key. Other zones can be included in the test in the same manner. When all of the required zones have been selected, press the **ent** key to start the **Walk Test**.

Note: The **Selected Zones** option includes non-omittable zones.

Ending Walk Test

To abort the walk test option press the **esc** key, otherwise the walk test option remains active for 20 minutes after the last key press.

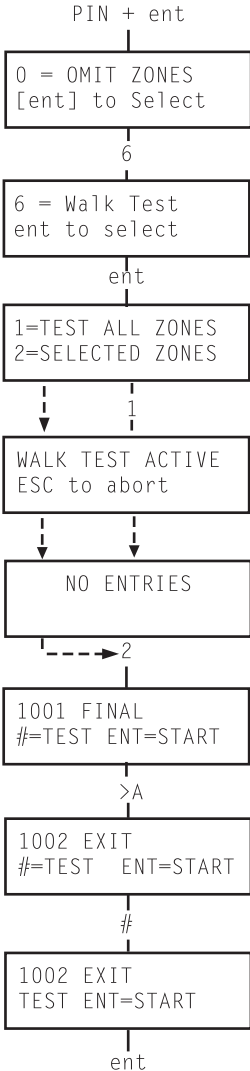

Time/Date (User Level 6)

Purpose

The **Time/Date** option allows the user to modify both the time (hours/minutes) and the date (day/month/year).

Selecting Time/Date

Enter the QUICK MENU. Press key 7 followed by the **ent** key. Once the **Time/Date** option has been selected, the time or date can be selected by pressing the **A>** or **<B** key.

Changing Time

To change the time press the **A>** key. The display prompts for a **New Time** in hours and minutes (HH:MM). When the new time is entered, the display immediately returns to the time or date selection screen. The system does not accept invalid times (greater than 23 hours, greater than 59 minutes). Pressing the **esc** key aborts the entry.

Changing Date

To change the date press the **<B** The display prompts for a **New Date** in days, months and years (DD/MM/YY). When the new date is entered, the display momentarily shows the day of the week, before returning to the time or date selection screen. The system does not accept invalid dates (e.g. **32/13/99**). Pressing the **esc** key aborts the entry.

Advance and Retard

It is possible to advance and retard the time to compensate for any variations in clock speed. Press the **#** key when in the time/date mode to select the clock speed adjustment. The range is 0 to 120 seconds per week. Pressing the ***** key will retard the time.

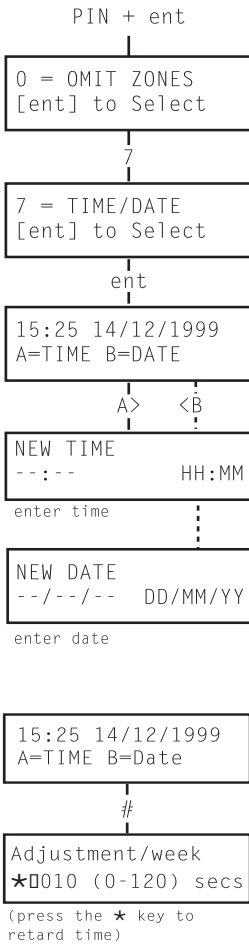

Codes (User Level 6)

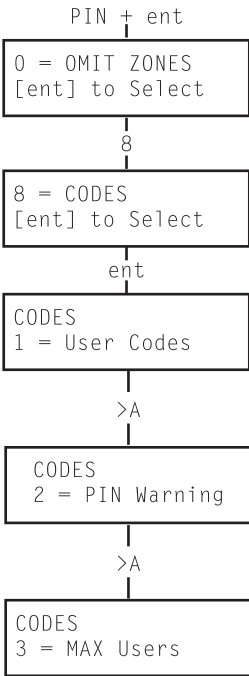

Purpose

The **Codes** menu option enables the managers, (user level 6), to allocate PINs and related information to users. The codes option is divided into three sub-menus:

1. User Codes

Sub divided into nine menus (depending on panel used and whether the group and **MAX Mode** options are enabled) that determine all of the access information for users with Personal Identification Numbers (PINs). This menu also assigns MAX details to user numbers.

2. Pin Warning

Available only on the Galaxy 128, 500, 504 and 512. This option determines the warning period given to users prior to the programmed **Pin Change** date.

Note: The valid period for **Pin Change** codes is programmed by the installation engineer.

3. Max Users (Pre V4 Only)

This option is only available if the MAX mode is enabled. The option is subdivided into two menus that assign the MAX card to users who do not have a PIN assigned.

Manager Code

The manager code is authorised to:

- Program the USER CODES option for each of the user codes.
- Allocate other codes to user level 6.
- Modify the manager PIN (the manager PIN cannot be deleted)
- Assign the MAX features to the code.

The manager code defaults to group choice when groups are enabled. The manager is able to toggle the group choice option on and off (using the * key) as required.

Galaxy 8 & 18

The manager code defaults to accessing the quick menu.

Note: The MAX is the Proximity Access Reader which can be connected to the Galaxy system. This also refers to the MicroMAX, the enhanced version of the MAX.

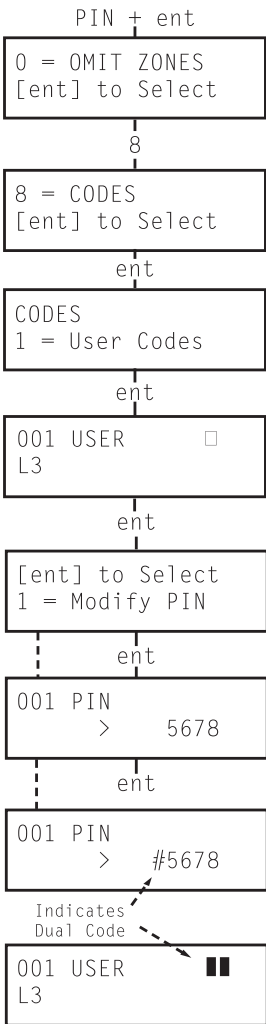

Selecting Codes

Enter the QUICK MENU. Press key **8** followed by the **ent** key.

User Codes

When the **Codes** option has been selected, press key **1** to access **User Codes**. Display each of the user numbers using key **A>**. Each user number offers options for PIN, level, name and where applicable time zones and groups. When the user number to be modified is displayed, press the **ent** key to access the **Modify Pin** option.

Modify Pin

The **Modify Pin** option allows a pin to be assigned to a user or an existing PIN to be modified. The PIN must be a four, five or six digit number that is unique to the system. If a duplicate PIN is assigned, the message **Duplicate Entry** is displayed. As each digit is entered it appears on the bottom line of the display. Pressing the * key erases the last digit displayed. Continued pressing of the *key will erase all of the digits. When the correct PIN has been assigned press the **ent** key to accept the programming and return to the previous menu level.

When a PIN has been assigned to a user number, a solid box (■) is displayed on the line of the user number details screen.

• Deleting a Pin

Existing PIN entries can be completely erased using the * key instead of a digit entry. When there is no PIN assigned to a user number a hollow square (□) is displayed in the top line of the users details screen.

• Assigning Dual Codes

To program a user code as a **Dual Code** press the # key while the **Modify PIN** option is selected. The # displays at the start of the assigned user PIN e.g. **#5678**. When a PIN has been assigned as a dual code two solid boxes (■■) are displayed in the top line of the users details screen.

• Dual Codes Operation

Entry of a single dual code cannot gain access to the menu, set or unset the system. The message **NO ACCESS – ADDITIONAL CODE** is displayed. A second dual code must be entered within 60 seconds to access the menu, set or unset the system. Dual codes can be of different levels. The highest level code entered determines the access level to the system.

• Galaxy 60, 128, 500, 504 & 512

A single entry of a dual code, without a second dual code entry within 60 seconds, results in an **Illegal Code** record in the EventLog. All outputs programmed as **Illegal Code** are activated.

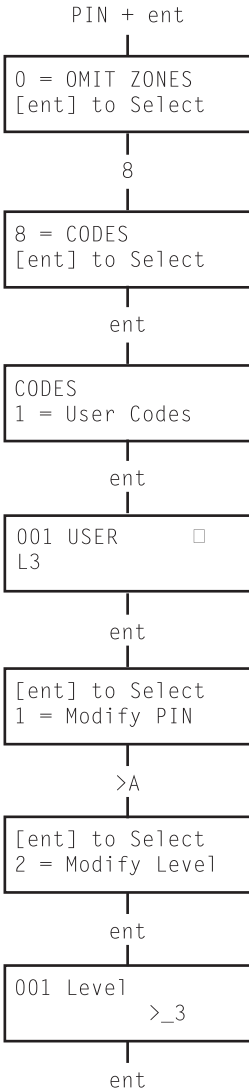

Modify Level

Each user is assigned an access level which determines the menu options available to the user (see p.7, Table 1. Menu Options). On selecting this option, enter the level to be assigned to the user and press the **ent** key to accept the programming and return to the previous menu level. See Table 2. User Access Levels, for access availability.

Level		Access Availability
0†	Guard	Entered into the event memory - no other option
1†	Cleaner	Can only set the system
2†	Caretaker	Can only set and unset the system
3	Users	Menu Options 11 - 19
4	Users	Menu Options 11 - 29
5	Users	Menu Options 11 - 39
6‡	Manager	Menu Options 11 - 49
† No access to menu functions. ‡ The manager code has a fixed level which cannot be changed.		

Table 2. User Access Levels

• Duress Code

1. Galaxy 18, 60, 128, 500, 504 and 512

If the # key is pressed while **Modify Level** is accessed, then the current code is assigned as a Duress Code. There is no limit to the number of codes which can be assigned as Duress. Entering a duress code at any time activates outputs programmed as **Duress or PA**.

2. Galaxy 8, 18, 60, 128, 500, 504 and 512

Any valid PIN followed by ## **ent** (the **ent** key can be replaced by either the **A>** or **<B** key) can be used as a Duress Code.

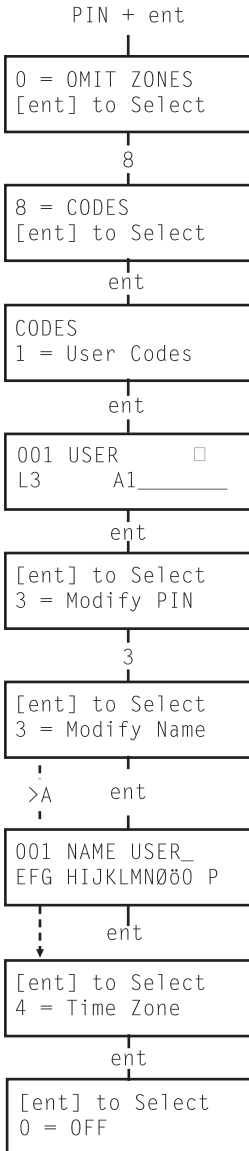

Use the A key to step through the four time zone options.

ent

• Quick Menu

All user codes default to the quick menu. This menu is made up of a selection of ten options (0 – 9) from the menu options 11 – 68. The user code level controls access to the quick menu. Any user can be upgraded from the quick menu to the full menu by assigning a * to the user while the **Modify Level** option is accessed. Therefore a user with a level *5 would have access to the full menu from options 11 – 39. No code can access both menus.

Note: The manager code defaults to the quick menu on the Galaxy 8 and 18, but defaults to the full menu on the Galaxy 60, 128, 500, 504 and 512.

Modify Name

This allows a name to be assigned to the user (maximum 8 characters). Each of the user codes default to the name **USER** and the manager defaults to **MGR**. The manager name cannot be changed. On selecting the **Modify Name** option, a section of the alpha-numeric that can be assigned to the user name is displayed on the bottom line of the keypad; the cursor flashes on the letter **L**. Press * to erase the letters of the default or previous name. When the previous name has been erased, use the **A>** or **<B** keys to move the cursor to the first letter of the name and press the **ent** key. The selected character appears on the top line, continue this process until the name is completed. The # key toggles between upper and lower case characters and the system library. Press **esc** to save the name and exit.

Time Zone (Galaxy 60, 128, 500, 504 and 512)

Managers can allocate time zones to user PINs when **TIMERS** have been programmed by the engineer. Time zones are used to disable the user PIN during the times (**ON to OFF**) programmed in **TIMER A** and **B**.

When **4 = TIME ZONE** displays, press the **ent** key. Using the **A>** key select the time zones option to be allocated to the PIN. The following time zones options are available:

- 0=OFF**
- 1=TIMER A**
- 2=TIMER B**
- 3=TIMER A+B**

The times assigned to **Timer A** and **Timer B** can be viewed using option **45 Timer Control**. No access will be granted if a code, assigned to 1=Timer A, 2=Timer B or 3= Timer A+B is entered out with the assigned times, an **Illegal Code** event is recorded in the log and any outputs programmed as **Illegal Code** are activated.

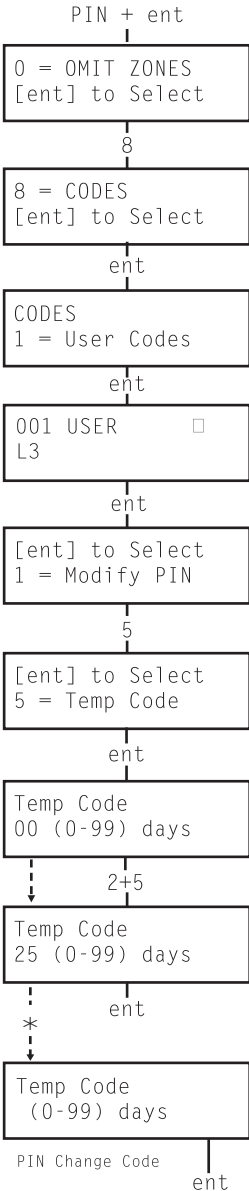

Temporary Codes (Galaxy 128, 500, 504 and 512)

Temporary Codes allow a PIN to be temporarily allocated to a user. On selecting this option, enter the number of days (0 – 99) that the code is to remain active. The default setting of **0** indicates that the code is permanent. A temporary code expires and is removed from the codes list at midnight after the assigned number of days. A code that has been assigned as a **Temporary Code** is indicated on the user code display by a **^** between the user number and the user name, e.g. **001^ USER**.

Note: The manager code cannot be assigned as a **Temporary Code**.

Pin Change (Galaxy 128, 500, 504 and 512)

To program a user code as a **PIN Change** code, select the **Temporary Codes** option and press the * key instead of a number of days for a temporary code. Press the **ent** key to accept the programming and return to the previous menu level. A code assigned as a **PIN Change** code is indicated on the user code display by a * between the user number and the user name, e.g. **001 * USER**. If a user is assigned the **PIN Change** feature in the **Temporary Code** option, the user must assign a new PIN after a predetermined period of time otherwise the PIN expires and is no longer operational. A notification (1 – 28 days) that the PIN requires to be changed can be assigned using the **PIN Warning** option. This prompts the user to assign a new code whenever the expiring code is entered during the PIN Warning period (except during system unsetting). The new PIN must be four to six digits long and must be different from any current PIN. The new PIN must be re-entered and if confirmed, returns the user to the banner. If the **esc** key is pressed or the new PIN entered is invalid, the user may continue to use the panel as normal. The next PIN entry will prompt the PIN change.

Note: If the user has not entered a new PIN by the end of the PIN Warning period, then the PIN is erased on the next unsetting of the system.

Modify Groups (Galaxy 18, 60, 128, 500, 504 and 512)

This option determines the system groups that the user has access to and operational control over. The **Modify Groups** option is only available when the **Group Mode** has been enabled by the engineer. The system defaults to groups disabled.

Groups allocated to the user are displayed when the **Modify Groups** option is selected. All users default to Group 1. Pressing the group number toggles the group assigned to the user. e.g. Pressing **2** and **3** assigns Groups 2 and 3 to the user. Pressing **1** (while group 1 is already assigned) removes group 1 from the user code. To assign group choice to the user, press the * key. When the required groups have been assigned to the user, press the **ent** key to accept the programming and return to the previous menu level.

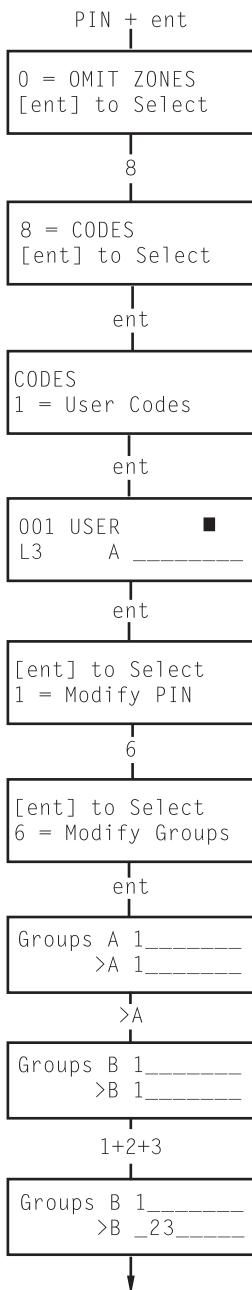

• Galaxy 500, 504 and 512

The Galaxy 500 has 16 groups, the 504 and 512 have 32 groups. The groups are displayed on the keypad in blocks of eight groups which are labelled A, B, C and D:

Use **A>** or **<B** keys to move between the group blocks. Press keys 1 – 8 to assign the groups in each block to the user.

Group Block	Physical Group
A1-8†	1-8
B1-8†	9-16
C1-8	17-24
D1-8	25-32
† Groups available on the Galaxy 500.	

• Single Groups

A user can be assigned to any single group. In this case a user can only access, set and unset the single group.

• Multiple Groups

Users can be allocated to more than one group in which case access and operation are collective. The user cannot choose to operate on a single or combination of the assigned groups.

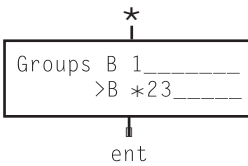

•Group Choice

Users can be allocated to more than one group, but also have the choice of which of the allocated groups to view, set or unset. Pressing * key while assigning groups to the user assigns the group choice feature.

- Notes:**
- 1.The manager has fixed access to all system groups. This cannot be reprogrammed.
 - 2.The manager is assigned group choice by default, but the feature can be removed.
 - 3.Users authorised to access the **Codes** option can only assign groups that have been assigned to their user code. A user who does not have access to group 4, cannot assign group 4 to another user code.

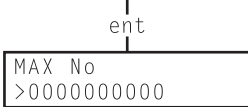
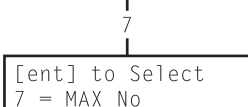
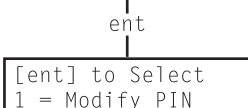
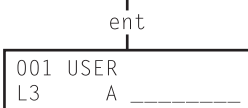
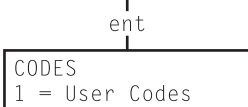
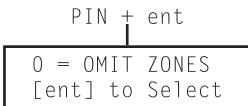

Enter new MAX number
ent

Max Number

Each MAX card has a unique 10 digit number laser etched onto it. A MAX card is assigned to a user by entering this number in the **Max No** option. The number identifies the MAX card to the system and references it to the user it has been assigned to.

Each **MAX Number** defaults to **0000000000** (ten zero's):

1. Press and hold the B key until the zeros are deleted.
2. Enter the unique 10 digit number which is laser etched onto the MAX card.
3. Press the **ent** key to save the programming and return to the previous menu.

Note: A MAX number can be assigned to a user code that does not have a PIN allocated to it. All other options for this user are valid for the MAX card. It is recommended that MAX numbers should be assigned to users not requiring a PIN at the **Max Users** menu option.

When a MAX number has been assigned to a user number, a lower case (m) is displayed on the top line of the user number details screen.

A # assigned to the max number makes the max function dual focus, ie it needs the pin entered first. A star * assigned to the max number makes the card dual access, ie it needs another card to open doors.

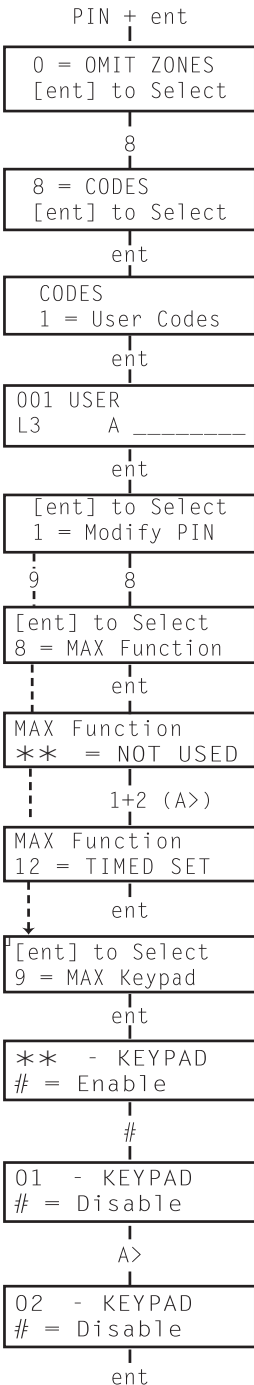

Max Function

The MAX card can be assigned to a single menu option. The user must be authorised to access the menu option, either by the user level assigned or by having the menu option access level changed by the engineer.

The default option is **Not Used**. A new option is assigned by scrolling using the **A>** or **<B** keys until the required option is displayed or directly entering the option number using the keypad digits. Select the function by pressing the **ent** key

Max Keypad

The menu option assigned to the MAX card can be limited to operate on a single keypad. On selecting this option the display shows **, indicating that a keypad has not been specified. To specify a keypad, press the # key. The address of the first keypad on the system is displayed. Use the **A>** or **<B** key to select the required keypad and press the **ent** key to accept the programming.

Note: A black flashing square over the first digit of the keypad address indicates the address of the keypad currently being used.

•“Card- Held” Max Operation

The MAX function is activated when the card is held directly in front of a MAX reader for three seconds. The MAX reader must be assigned a common group to the MAX user. The keypad specified in the **Max Keypad** option displays the assigned MAX function.

Note: If the specified keypad is in use, then the option does not display. If the MAX function is an “action” type option, e.g. **12 = Timed Set**, then the function is carried out.

If no keypad is specified (**), the MAX menu option will operate on all keypads that share the groups of the MAX user. If there is more than one keypad, the message **Press any key** is displayed on all valid keypads. Press any key to activate the function on that keypad. Press no key within five seconds and the function automatically activates on all keypads.

Forgive Antipassback

When the Timed Antipassback feature is enabled, it will prevent more than one use of any particular card at a particular reader within a preset time period. The forgive function is available to clear all or particular antipassback restrictions in force.

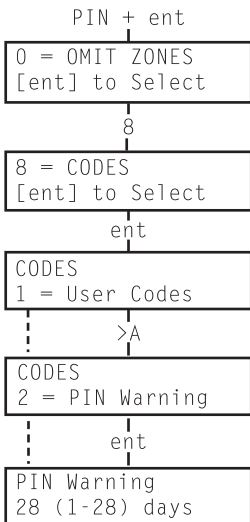

Pin Warning

This option determines the number of days notification before the expiry date of any user codes programmed as **PIN Change**. During the notification period, the user is prompted to enter a new code on entry of the expiring PIN. The default period is **99** days, with a programmable range of **1 – 99**. If a user does not assign a new code by the end of the **PIN Warning** period, then the code is erased on the next unsetting of the system.

Note: The **PIN Warning** ends on the last day of the month, the PIN expires on the first day of the following month.

Max Users (Pre V4 Only)

This option is used to assign additional MAX users to the system without allocating PINs, MAX users are only authorised to operate the Access Control functions of the MAX modules.

Enter the **Codes** option and select **3 = MAX Users**. Press the **ent** key to display the first MAX user number. Each of the users can be displayed using the **A>** and **<B** keys, or a specific user can be selected by entering the required user number. When the required code is displayed, press the **ent** key; to display **1 = MAX Number**.

Each MAX card has a unique 10 digit number laser etched onto it. A MAX card is assigned to a user by entering this number in the **MAX No** option. The number identifies the MAX card to the system and references it to the user it has been assigned to.

Each **MAX Number** defaults to **0000000000** (ten zero's):

1. Press and hold the B key until the zeros are deleted.
2. Enter the unique 10 digit number which is laser etched onto the MAX card.
3. Press the **ent** key to save the programming and return to the previous menu.

Note: A MAX number can be assigned to a user code that does not have a PIN allocated to it. All other options for this user are valid for the MAX card. It is recommended that MAX numbers should be assigned to users not requiring a PIN at the **Max Users** menu option.

When a MAX number has been assigned to a MAX user number, a solid box (■) is displayed on the top line of the MAX user number details screen.

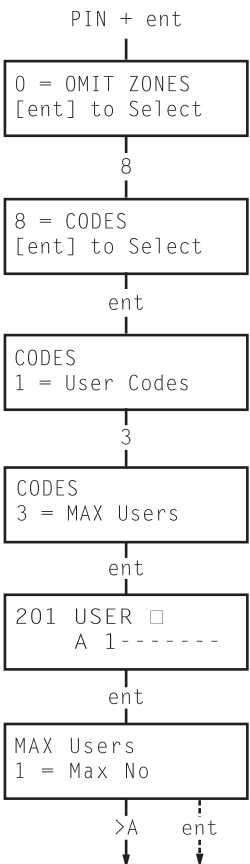

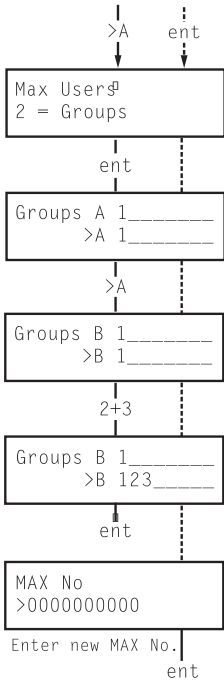

Groups (Pre V4 Only)

This option assigns group access to the MAX user. The MAX user must be assigned a group that is common to the MAX module to permit the access control functions to operate. If the MAX user does not have access to the group assigned to the module, the access control functions are denied. The **Modify Groups** option is only available when groups have been enabled by the engineer. The system defaults to groups disabled.

On selecting the Modify Groups option, the groups currently allocated to the user are displayed. All users default to group 1. Pressing the group number toggles the group assigned to the user. Pressing **2** and **3** assigns groups 2 and 3 to the user. Pressing **1** (while group 1 is already assigned) removes group 1 from the MAX user; press the **ent** key to accept the programming and return to the previous menu level.

- **Galaxy 500, 504 and 512**

The Galaxy 500 has 16 groups, the 504 and 512 have 32 groups. These are displayed on the keypad in blocks of eight groups, labelled A, B, C and D. Use keys **A>** or **<B** to move between the group blocks. Press keys 1 – 8 to assign the groups in each block to the user.

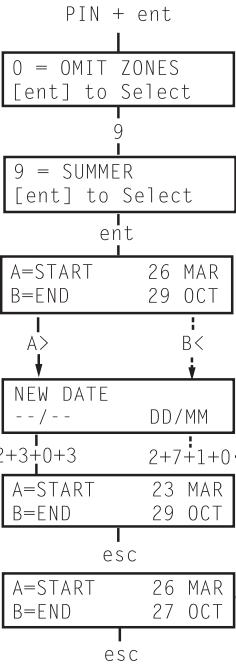

Summer (User Level 6)

On the first day of each year, the British Summer Time (**BST**) **Start** date is set to the last Sunday in March and the **End** date is set to the last Sunday in October.

The operation of the **Summer** option is as follows: At 01 : 00 hours on the **Start** date, the system clock advances to 02 : 00 hours. At 02 : 00 hours on the **End** date, the system clock goes back to 01 : 00 hours (midnight).

Note: The time always changes with reference to GMT. For example, Italy which is + 1 hour would be:

Last Sunday in March - 02.00 to 03.00
 Last Sunday in October - 03.00 to 02.00

The **Start** and **End** dates can be reprogrammed by authorised user codes. Press the **A>** key to modify the **Start** date or the **<B** key to select the **End** date. The new date must be a valid four digit number in the day month format (dd/mm).

Galaxy 504

The **Summer** option can only be modified by the engineer.

AVOIDING FALSE ALARMS

False alarms are inconvenient and may be costly. Police can withhold response from consistent offenders.

Here are nine points to help avoid false alarms.

1. Be sure you fully understand how to operate the alarm system. In your absence someone thoroughly instructed, should be available to operate the system.
2. Before leaving the premises ensure that all doors and windows are securely closed.
3. Where passive infra red or movement detectors are installed make sure the areas are kept free from all animals or birds. Particular attention should be paid to swinging signs, fluorescent lights, Christmas decorations, electric fans, heating or ventilating systems. These should be switched off if possible
4. Always follow the exit/entry route procedure agreed with your alarm installer.
5. Treat the alarm components with care to ensure they are not damaged.
6. Consult your alarm installer about changes to your building and its contents if you think they may affect the alarm system or its performance.
7. Always report alarm activation to your alarm installer. If necessary, an engineer will be sent to check the system.
8. If opening or closing times are monitored by a central station be sure you notify them of any variations from the agreed times or password.
9. The system should be fitted with a stand-by battery (not included) which will operate the system for a limited period in the event of a mains failure. Please ensure that the mains is restored as quickly as possible so that the stand-by battery can be recharged.

ZONE REFERENCE TABLES

	Zone	Function	Description	Chime	Omit	Part
Galaxy 18 & 60	1001					
	1002					
Galaxy 60 only	1003					
	1004					

1011						
1012						
1013						
1014						
1015						
1016						
1017						
1018						

RIO	Zone	Function	Description	Chime	Omit	Part
	1					
	2					
	3					
	4					
	5					
	6					
	7					
	8					

RIO	Zone	Function	Description	Chime	Omit	Part
	1					
	2					
	3					
	4					
	5					
	6					
	7					
	8					

ALARM AND HELP MESSAGES

OTHER KEYPAD
IN USE

Other Keypad In Use (Galaxy 8 And 18 Only)

This message advises the user that the system is already in use. The Galaxy 8 and 18 allow only one user at a time.

ALARM IN
PROGRESS

Alarm In Progress

The system is currently in alarm condition and must be cancelled by a valid PIN or keyswitch operation.

PA
RESET REQUIRED

Pa Reset Required

After a PA (Personal Attack) zone has been activated, the system has to be reset by a high level code (such as a manager or engineer depending on the reset level setting).

CALL MANAGER
RESET REQUIRED

Manager Reset Required

Following an alarm activation, the system requires to be reset by a manager level code.

CALL ENGINEER
RESET REQUIRED

This message is displayed when a tamper alarm occurs.

NO ENTRIES

Engineer Reset Required

The system has been programmed for engineer reset following an alarm activation. The engineer must be called to reset the system before the user can set the alarm. Tamper alarms usually require an engineer to visit the site to check all modules on the system.

INVALID
OPTION

No Entries

This message appears if a user attempts to view or inspect the log and there is nothing in the log to be viewed or when the omit option is selected and there are no omissible zones on the system.

Invalid code

Invalid Selection

The option selected or value entered is illegal or out of range.

Option not
available

Invalid Code

The code entered is not a valid code registered in the system memory.

CALL ALARM CO.
QUOTE CODE XXXXX

Option Not Available

This option is provided by the engineer, where it is specifically required. Attempting to select an option when it has not been provided results in the display of

NO MODULE ADDED
ESC TO CONTINUE

Technistore Reset

Call the Alarm Monitoring Station and quote the five digit number displayed. Enter the number quoted by the monitoring station to reset the system.

No Modules Added

When exiting Engineer Mode the panel does not detect the change in the number of modules. Press **esc** to continue.

INSTALLER DETAILS

Name: -----

Address: -----

Telephone: -----

Office Hours: -----

Other Times: -----

Account No.: -----

Honeywell Security
2 Redwood Crescent
Peel Park Campus
East Kilbride
G74 5PA